

Specifications

Nominal Voltage		2 V
Capacity (25°C)	10HR(1.80V)	150 Ah
	3HR(1.75V)	114.9Ah
	1HR(1.75V)	84.7Ah
Dimension	Length	171 ± 2mm (6.73inch)
	Width	102 ± 1mm (4.02inch)
	Height	206 ± 2mm (8.11inch)
	Total Height	230 ± 2mm (9.06inch)
Approx. Weight		8.1kg (17.9lbs) ± 4%
Terminal type		T11
Internal resistance (Fully charged, 25°C)		Approx. 0.6m Ω
Capacity affected by temperature (10HR)	40°C	102%
	25°C	100%
	0°C	85%
	-15°C	65%
Self-discharge (25°C)	3 month	Remaining Capacity: 91%
	6 month	Remaining Capacity: 82%
	12 month	Remaining Capacity: 65%
Nominal operating temperature		25°C ± 3°C (77°F ± 5°F)
Operating temperature range	Discharge	-15°C ~ 50°C (5°F ~ 122°F)
	Charge	-10°C ~ 50°C (14°F ~ 122°F)
	Storage	-20°C ~ 50°C (-4°F ~ 122°F)
Float charging voltage(25°C)		2.25 to 2.30V Temperature compensation: -3mV/°C
Cyclic charging voltage(25°C)		2.42 to 2.48V Temperature compensation: -5mV/°C
Maximum charging current		30A
Terminal material		Copper
Maximum discharge current		1200A(5 sec.)
Designed floating life(20°C)		20 years

- ◆ Absorbent glass mat technology;
- ◆ Recognized by UL & CE;
- ◆ ABS container.

Constant Current Discharge Characteristics (A, 25°C)

F.V/TIME	15min	30min	60min	2h	3h	4h	5h	6h	8h	10h	20h
1.60V	203	135	90.0	54.8	39.0	31.4	27.2	23.4	18.4	15.3	8.02
1.65V	198	132	88.7	54.5	38.8	31.2	27.1	23.3	18.3	15.2	8.00
1.70V	190	128	86.4	54.0	38.5	31.0	26.9	23.1	18.1	15.2	7.98
1.75V	184	125	84.7	53.2	38.3	30.8	26.7	23.0	18.0	15.1	7.93
1.80V	174	121	82.1	51.8	37.1	29.8	25.9	22.3	17.5	15.0	7.88

Constant Power Discharge Characteristics (Watt, 25°C)

F.V/TIME	15min	30min	60min	2h	3h	4h	5h	6h	8h	10h	20h
1.60V	371	252	171	106	76.5	61.5	53.7	46.1	36.5	30.4	16.0
1.65V	362	247	168	105	76.0	61.1	53.3	45.8	36.3	30.3	16.0
1.70V	348	240	164	104	75.5	60.7	53.0	45.5	36.1	30.2	16.0
1.75V	336	234	161	103	75.0	60.3	52.6	45.2	35.8	30.1	15.9
1.80V	319	225	156	100	72.7	58.5	51.0	43.9	34.7	29.9	15.8

Note: The above characteristics data can be obtained within three charge/discharge cycles.

Dimensions

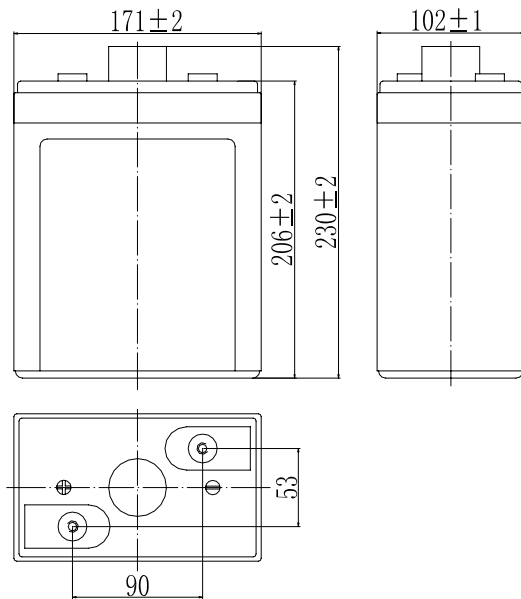

Terminal

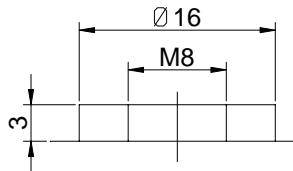

Terminal T11

Discharge Characteristics(25°C)

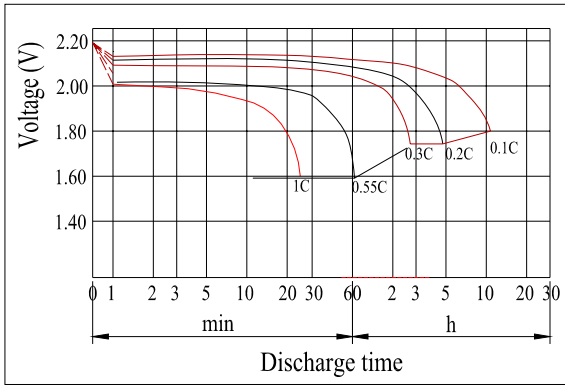

Charging Characteristics(25°C)

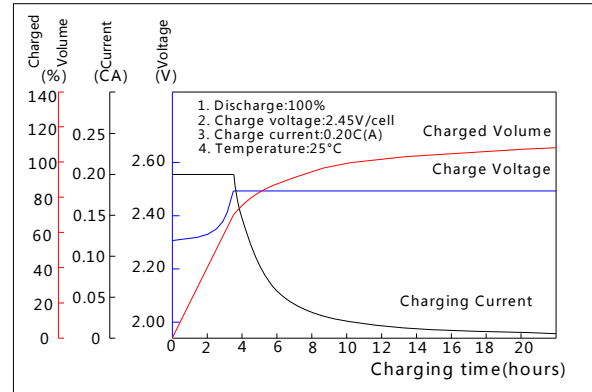

Effect of Temperature on Capacity

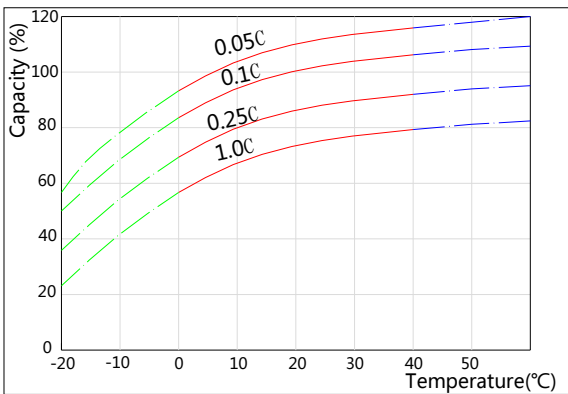

Self-discharge Characteristics

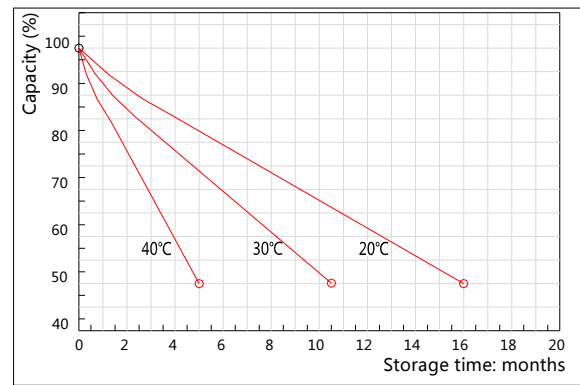

The Relationship for Open Circuit Voltage and Residual Capacity (25°C)

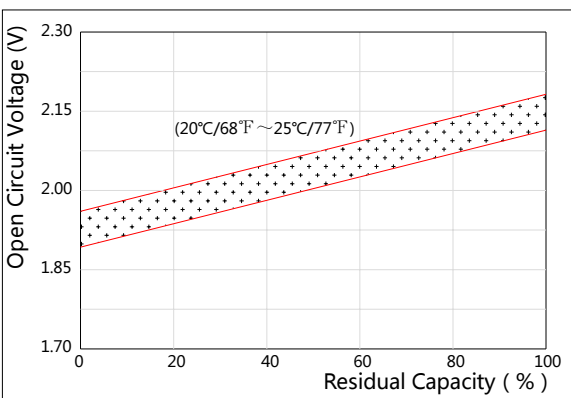

The Relationship for Charging Voltage and Temperature

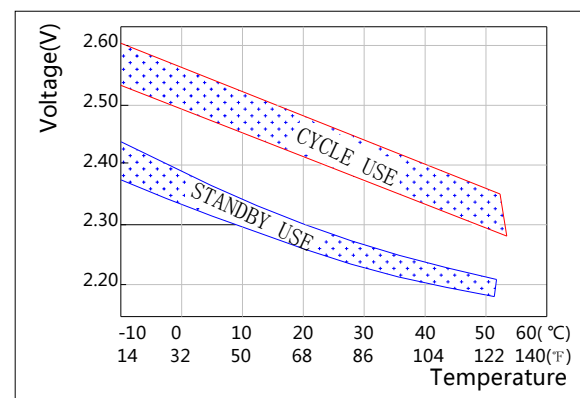

Floating Life on Temperature

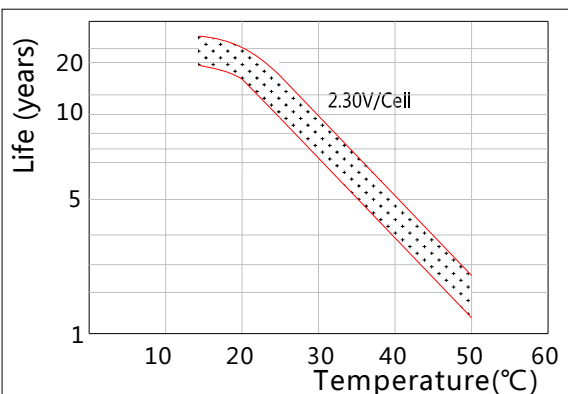

Cycle Life on D.O.D(25°C)

