

Specifications

Nominal Voltage		12 V
Capacity (25°C)	10HR(10.8V)	35 Ah
	5HR(10.5V)	30.6Ah
	1HR(9.60V)	21.7Ah
Dimension	Length	195 ± 2mm (7.68inch)
	Width	130 ± 1mm (5.12inch)
	Height	155 ± 2mm (6.10inch)
	Total Height	T7: 180 ± 2mm (7.09inch) T9: 166 ± 2mm (6.54inch)
Approx. Weight		10.2kg (22.4lbs) ± 4%
Terminal type		T7/T9
Internal resistance (Fully charged, 25°C)		Approx. 9m Ω
Capacity affected by temperature (10HR)	40°C	102%
	25°C	100%
	0°C	85%
	-15°C	65%
Self-discharge (25°C)	3 month	Remaining Capacity: 91%
	6 month	Remaining Capacity: 82%
	12 month	Remaining Capacity: 65%
Nominal operating temperature		25°C ± 3°C (77°F ± 5°F)
Operating temperature range	Discharge	-15°C ~ 50°C (5°F ~ 122°F)
	Charge	-10°C ~ 50°C (14°F ~ 122°F)
	Storage	-20°C ~ 50°C (-4°F ~ 122°F)
Float charging voltage(25°C)		13.50 to 13.80V Temperature compensation: -18mV/°C
Cyclic charging voltage(25°C)		14.50 to 14.90V Temperature compensation: -30mV/°C
Maximum charging current		10.5A
Terminal material		T7: Lead, T9: Copper
Maximum discharge current		350A(5 sec.)
Designed floating life(20°C)		12 years

- ◆ Absorbent glass mat technology;
- ◆ Recognized by UL & CE;
- ◆ ABS container.



Dimensions

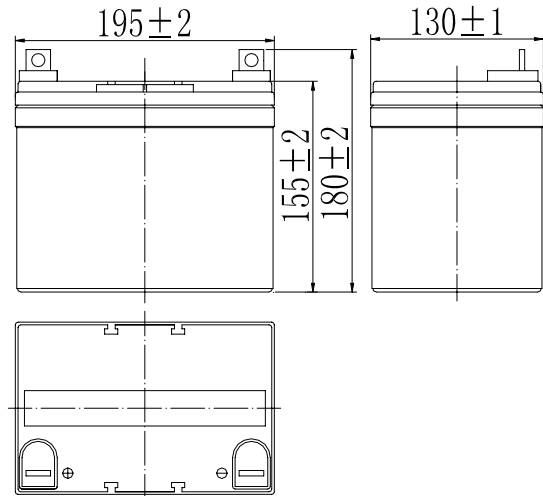

Terminal

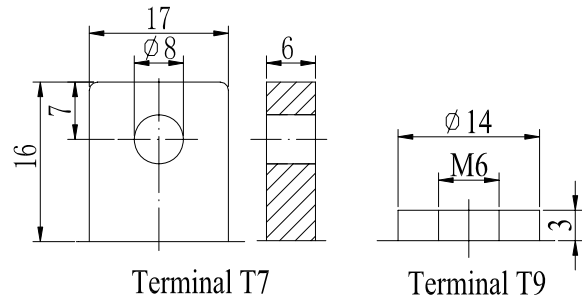

Constant Current Discharge Characteristics (A, 25°C)

F.V/TIME	10min	15min	30min	60min	2h	3h	4h	5h	8h	10h	20h
9.60V	73.5	57.8	35.0	21.7	12.8	8.93	7.32	6.25	4.28	3.56	1.87
9.90V	71.3	56.4	34.3	21.4	12.7	8.87	7.28	6.21	4.26	3.56	1.87
10.2V	68.4	54.3	33.3	20.8	12.6	8.81	7.23	6.17	4.23	3.55	1.86
10.5V	65.4	52.4	32.4	20.4	12.4	8.75	7.18	6.13	4.20	3.52	1.85
10.8V	61.7	49.7	31.3	19.8	12.1	8.49	6.96	5.94	4.07	3.50	1.84

Constant Power Discharge Characteristics (Watt, 25°C)

F.V/TIME	10min	15min	30min	60min	2h	3h	4h	5h	8h	10h	20h
9.60V	794	634	393	247	148	105	86.1	73.8	50.9	42.5	22.4
9.90V	770	619	385	244	147	104	85.6	73.4	50.6	42.5	22.4
10.2V	738	596	373	237	146	104	85.0	72.9	50.2	42.3	22.3
10.5V	706	576	364	233	144	103	84.4	72.4	49.9	42.1	22.2
10.8V	667	545	351	226	140	99.8	81.8	70.2	48.4	41.8	22.1

Note: The above characteristics data can be obtained within three charge/discharge cycles.

Discharge Characteristics(25°C)

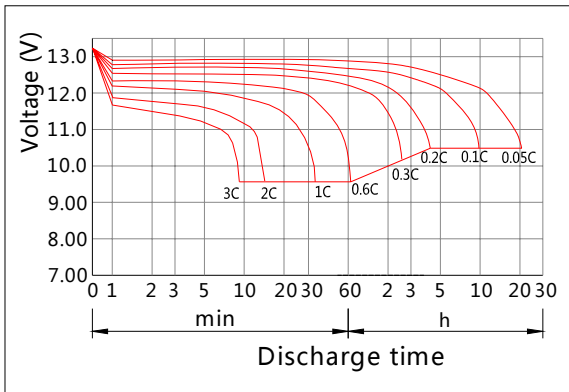

Charging Characteristics(25°C)

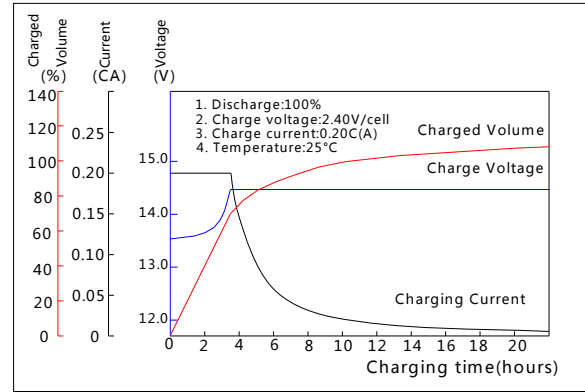

Effect of Temperature on Capacity

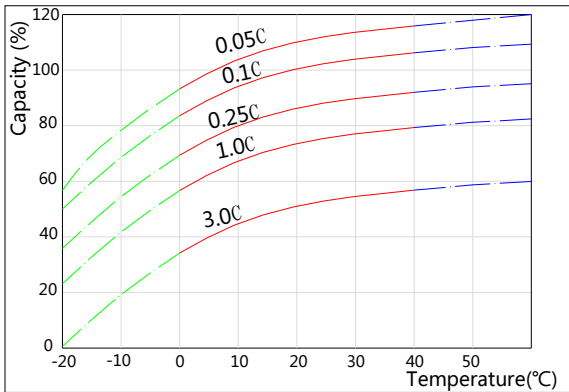

Self-discharge Characteristics

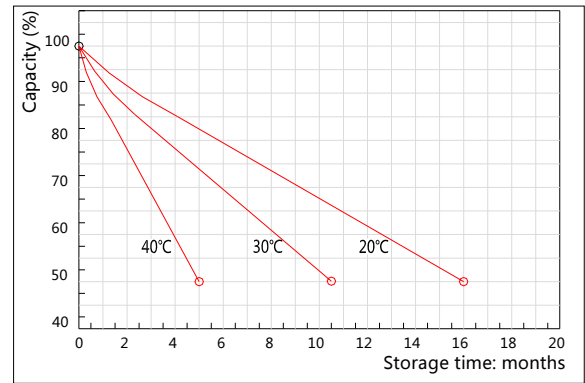

The Relationship for Open Circuit Voltage and Residual Capacity (25°C)

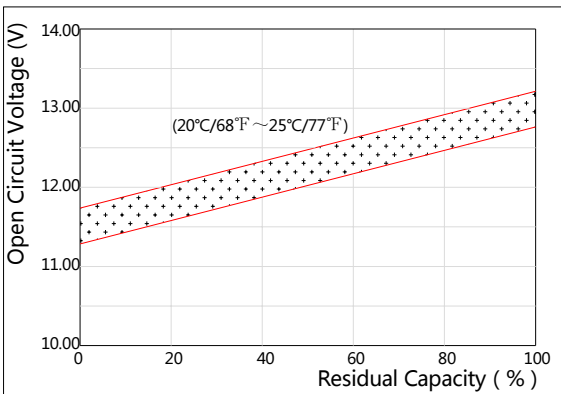

The Relationship for Charging Voltage and Temperature

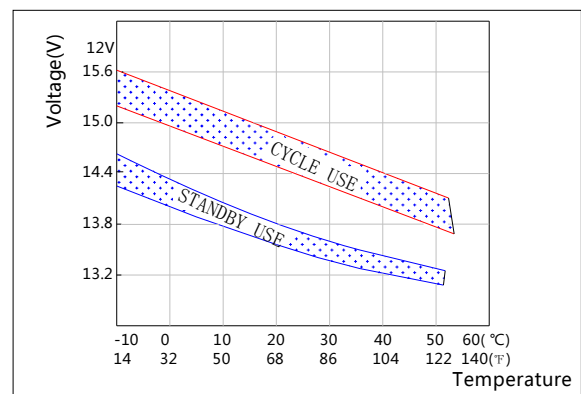

Floating Life on Temperature

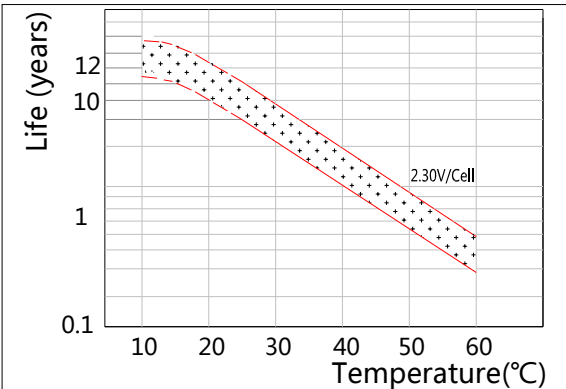

Cycle Life on D.O.D(25°C)

