

## GENERAL FEATURES

- Environmentally friendly
- Thick plate with high Tin low Calcium alloy
- High Reliability and Good Quality
- Deep Discharge Recovery
- High Power Density
- Long Service Life, in Float or Cyclic

## APPLICATIONS

- Solar & Wind energy system
- Cable TV Systems
- Telecom systems
- Wheel chair & Golf Car
- Marine Equipment
- Railway Systems
- Emergency Power System



## DIMENSIONS & WEIGHT

Length(mm)	350±1
Width(mm)	167±1
Height(mm)	178±1
Total Height(mm)	178±1
Weight(kg)	23.3±3%

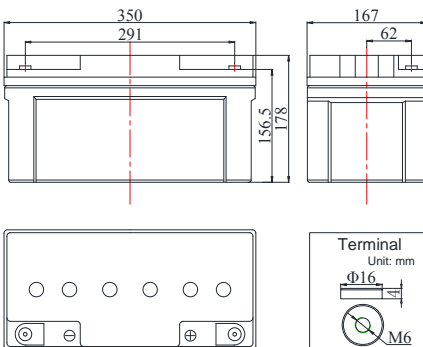

## COMPLIED STANDARDS

IEC 60896-21/22	JIS C8704
YD/T799	BS6290 part4
GB/T 19638	UL 1989

## TECHNICAL SPECIFICATIONS



Nominal Voltage		12V(6 cells per unit)
Design Floating Life @25°C		12 Years
Nominal Capacity @25°C(20 hour rate@3.50A,10.50V)		70Ah
Capacity @25°C	10 hour rate (6.37A,10.8V)	63.7Ah
	5 hour rate (11.1A,10.5V)	55.5Ah
	1 hour rate (38.9A,9.6V)	38.9Ah
Internal Resistance	Full Charged Battery@25°C	≤8.3mΩ
Ambient Temperature	Discharge	-20°C~50°C
	Charge	-20°C~50°C
	Storage	-20°C~50°C
Max.Discharge Current@25°C		700A(5s)
Capacity affected by Temperature (10 hr Capacity )	40°C	102%
	25°C	100%
	0°C	85%
	-15°C	65%
Self-Discharge@25°C per Month		3%
Charge (Constant Voltage) @25°C	Standby Use	Initial Charging Current Less than 15.75A Voltage 13.6-13.8V
	Cycle Use	Initial Charging Current Less than 15.75A Voltage 14.4-14.9V

## BATTERY DISCHARGE TABEL

### Discharge Constant Current per Cell (Amperes at 25°C)

F.V/Time	15min	30min	45min	1h	2h	3h	5h	8h	10h	20h	100h
1.60V	90.1	57.5	42.3	38.9	24.7	17.4	11.8	7.8	6.93	3.71	0.84
1.67V	88.5	56.5	41.5	38.2	24.2	17.0	11.6	7.6	6.79	3.64	0.83
1.70V	86.8	55.4	40.7	37.5	23.8	16.7	11.3	7.5	6.65	3.57	0.81
1.75V	85.2	54.4	40.0	36.8	23.3	16.4	11.1	7.4	6.58	3.50	0.79
1.80V	81.9	52.3	38.4	35.4	22.4	15.8	10.7	7.1	6.37	3.47	0.78

### Discharge Constant Power per Cell (Watts at 25°C)

F.V/Time	15min	30min	45min	1h	2h	3h	5h	8h	10h	20h	100h
1.60V	173.4	110.7	81.4	74.7	47.5	33.3	22.7	14.9	13.4	7.2	1.62
1.67V	170.2	108.7	79.9	73.4	46.6	32.8	22.3	14.7	13.1	7.1	1.58
1.70V	167.1	106.7	78.4	72.0	45.8	32.1	21.8	14.4	12.9	7.0	1.55
1.75V	163.9	104.7	76.9	70.6	44.9	31.5	21.4	14.1	12.6	6.9	1.53
1.80V	157.6	100.7	74.0	67.9	43.2	30.3	20.7	13.6	12.1	6.7	1.50

**Note** The above data are average values, and can be obtained within 3 charge/discharge cycles. These are not minimum values. Cell and battery designs/specifications are subject to modification without notice. Contact MCA for the latest information.

## PERFORMANCE CHARACTERISTICS

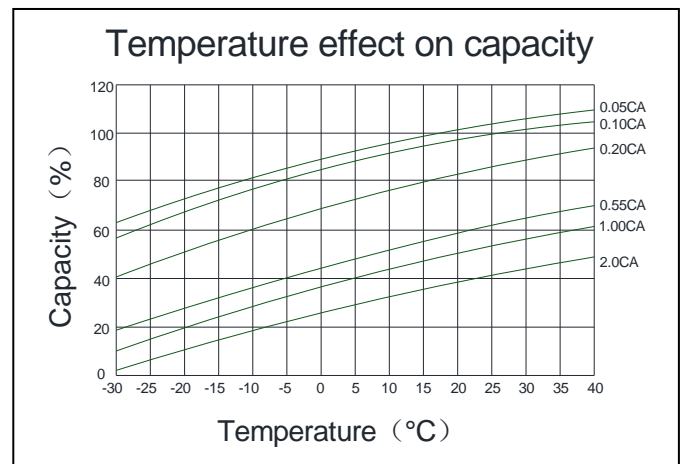
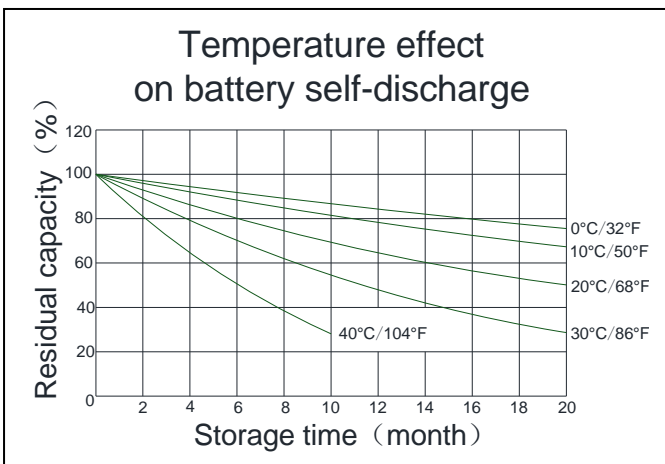
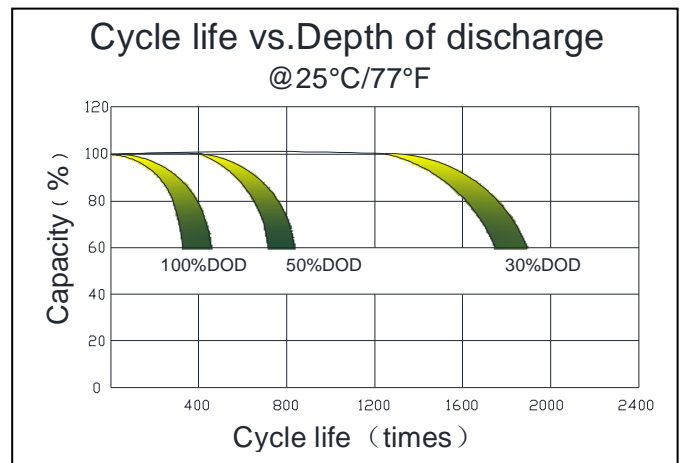
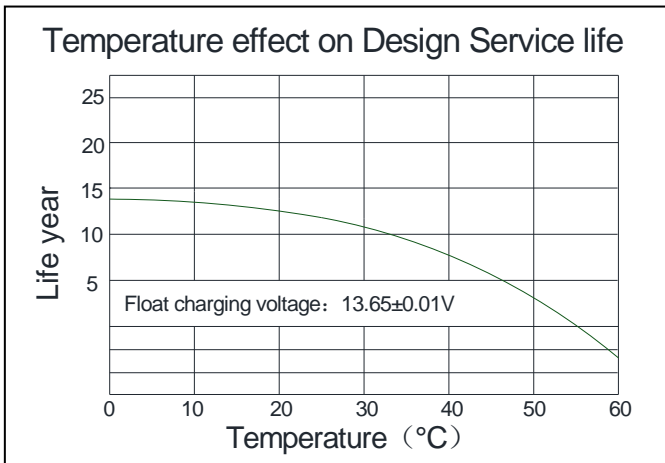
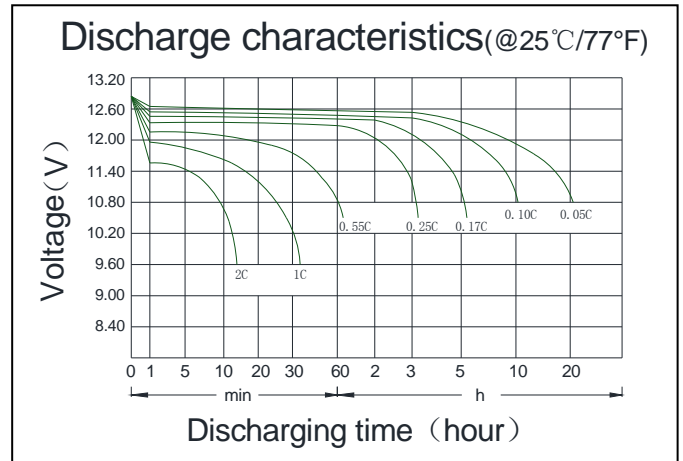
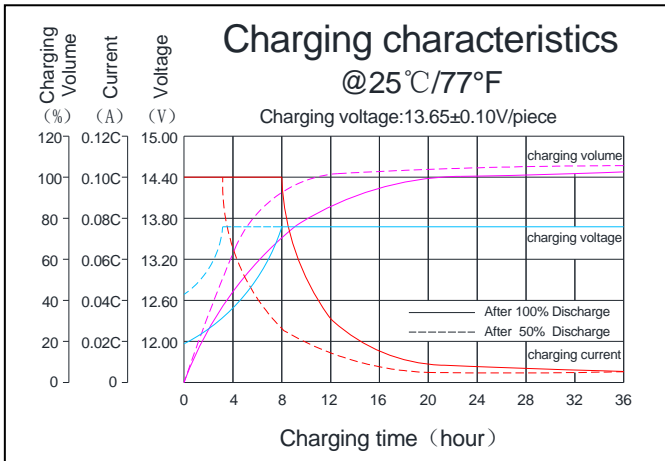

## BATTERY CONSTRUCTION

Component	Positive plate	Negative plate	Container & Cover	Safety valve	Terminal	Separator	Electrolyte	Pillar seal
Features	Thick high Sn low Ca grid with special paste	Balanced Pb-Ca grid for improved recombination efficiency	ABS (UL94-V0 optional)	Flame Si-Rubber and aging resistor	Female Copper Insert M6 (torque: 4~6N.m)	Advanced AGM separator for high pressure cell design	Dilute high purity sulphuric acid	Two layers epoxy resin seal