

Solar Series SLA Battery

Solar Series

By combining the newly developed nano gel electrolyte and high density positive plate paste, BSB Solar series Valve-regulated lead acid batteries offers high daily cycle life and high recharge efficiency at the very low charge current. The acid stratification is highly depressed by adding of gel electrolyte. This range battery is highly suited to energy storage for renewable energy such as PV and wind turbine power systems applications.

Application

- Photovoltaic system
- Renewable Energy System
- Electric Utility
- Outdoor control Equipment
- Railroad Utility

General Features

- 12 years float life at 20°C
- Up to 5 years design life at renewable energy applications
- Wide operating temperature range of -15 to 60°C
- Nano gel electrolyte eliminate the acid stratification and prolong cycle life
- Round trip efficiency as high as 85%
- Thick positive flat plate with high density paste
- Low self-discharge rate and long shelf life(1 year at 25°C)
- Excellent deep discharge recovery capability

Construction

- ComponentRaw material
- PositiveLead dioxide
- NegativeLead
- ContainerABS
- CoverABS
- SealantEpoxy Resin
- Safety valveEPDR
- TerminalCopper
- SeparatorAGM
- ElectrolyteHybrid Gel

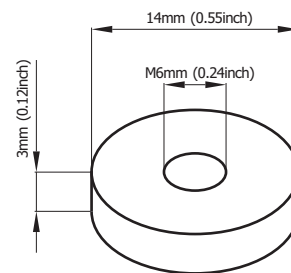

Terminal Dimensions

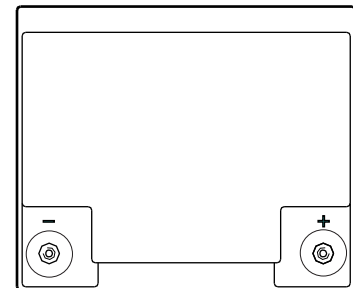
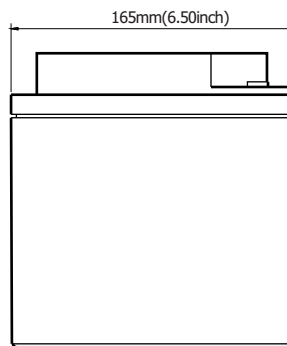
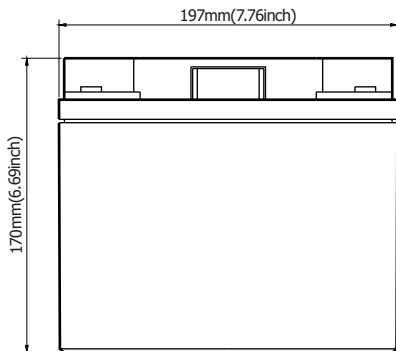

| | | | | |
|----------------------------------|---|-------------------|-----------------------|--------------------|
| Battery Model | Solar 12-44 | | | |
| Designed Floating Life | 12 Years | | | |
| Designed Cycle Life | 5 Years | | | |
| Capacity(20°C) | 10HR(4.4A,1.80V) | 24HR(1.92A,1.80V) | 48HR(1.00A,1.80V) | 100HR(0.52A,1.80V) |
| | 44AH | 46AH | 48AH | 52AH |
| Dimensions | Length | Width | Height | Total Height |
| | 197mm(7.76inch) | 165mm(6.50inch) | 170mm(6.69inch) | 170mm(6.69inch) |
| Approx. Weight | 13.5Kg (29.8 lbs) | | | |
| Internal Resistance | Full charged at 20°C: 0.0095 Ohm | | | |
| Self Discharge | 3% of capacity declined per month at (20°C) | | | |
| Capacity Affected by Temp.(20HR) | 40°C | 20°C | 0°C | -15°C |
| | 102% | 100% | 85% | 65% |
| Charge Voltage(20°C) | Cycle use | | Float use | |
| | 14.4-14.8V(-30mV/ °C), max. Current: 11A | | 13.6-13.8V(-20mV/ °C) | |

Solar Series SLA Battery

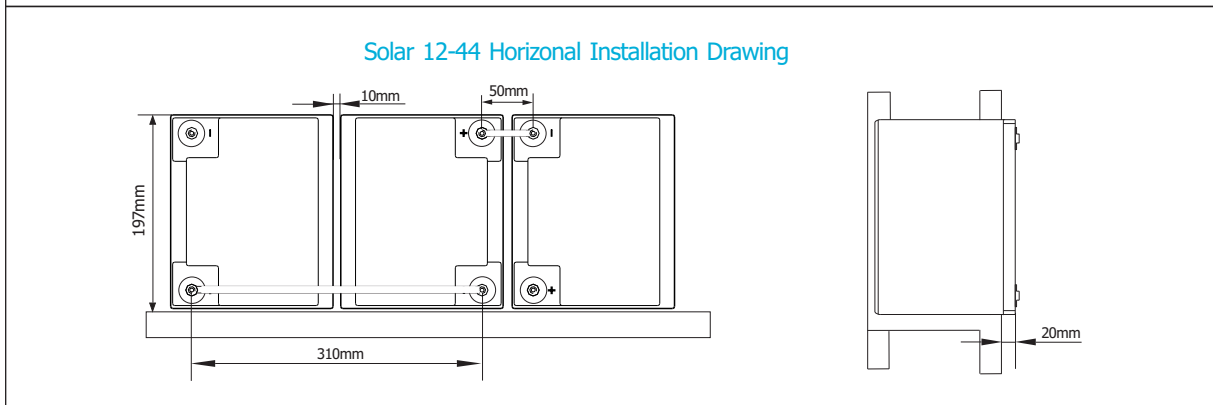
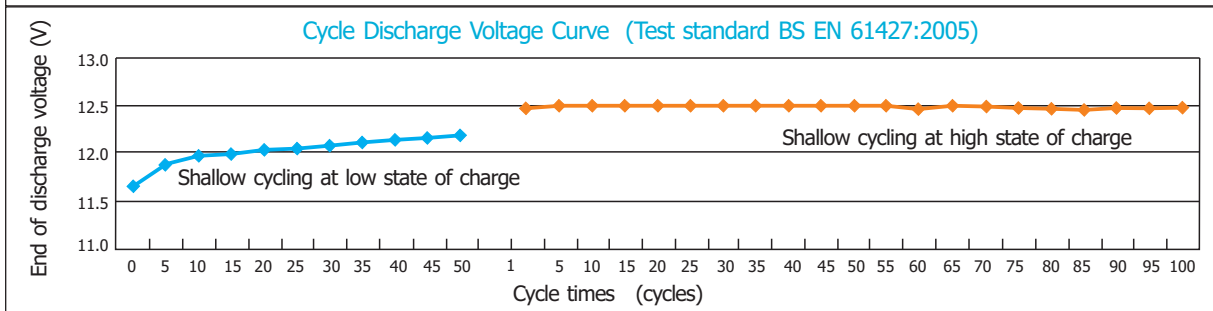
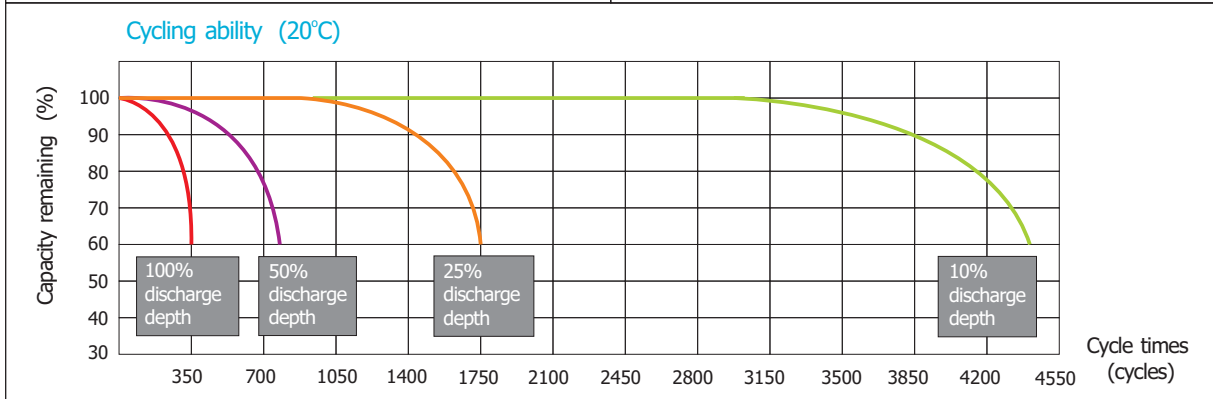
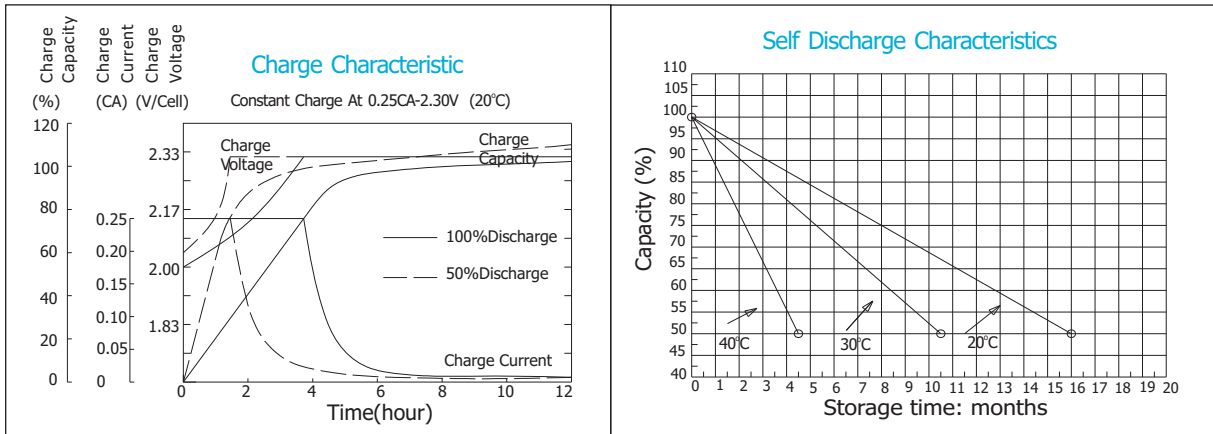

Constant current discharge ratings-amperes at 20°C

| TIME | 1HR | 3HR | 5HR | 10HR | 24HR | 48HR | 72HR | 100HR | 120HR |
|-----------------|------|------|------|------|------|------|------|-------|-------|
| CUT-OFF VOLTAGE | 1.80 | 1.80 | 1.80 | 1.80 | 1.80 | 1.80 | 1.80 | 1.80 | 1.80 |
| CAPACITY(AH) | 28 | 33 | 38 | 44 | 46 | 48 | 50 | 52 | 53 |