

## GENERAL FEATURES

- Environmentally friendly
- Can be used at vertical or horizontal orientation
- High Reliability and Good Quality
- High gas recombination efficiency
- High Power Density
- Maintenance-Free Operation

## APPLICATIONS

- UPS & EPS
- Emergency lighting Systems
- Medical Equipment
- Cable TV Systems
- Alarm Systems
- Electric Test Equipment
- Security Systems



## DIMENSIONS & WEIGHT

Length(mm)	70±1
Width(mm)	47±1
Height(mm)	101±1
Total Height(mm)	107±1
Weight(kg)	0.75±3%

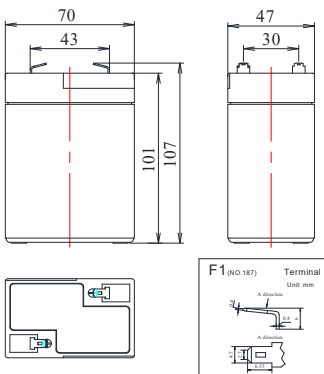

## COMPLIED STANDARDS

IEC 60896-21/22	JIS C8704
YD/T799	BS6290 part4
GB/T 19639	UL 1989

## TECHNICAL SPECIFICATIONS



Nominal Voltage		6V(3 cells per unit)
Design Floating Life @25°C		5 Years
Nominal Capacity @25°C (20 hour rate@0.225A,10.50V)		4.50Ah
Capacity @25°C	10 hour rate (0.42A,10.8V)	4.20Ah
	5 hour rate (0.80A,10.5V)	4.00Ah
	1 hour rate (2.94A,9.6V)	2.94Ah
Internal Resistance	Full Charged Battery@25°C	≤18.0mΩ
Ambient Temperature	Discharge	-20°C~50°C
	Charge	-20°C~50°C
	Storage	-20°C~50°C
Max.Discharge Current@25°C		67.5A(5s)
Capacity affected by Temperature (10 hr Capacity)	40°C	102%
	25°C	100%
	0°C	85%
	-15°C	65%
Self-Discharge@25°C per Month		3%
Charge (Constant Voltage) @25°C	Floating Charge	Initial Charging Current Less than 1.35A Voltage 13.6-13.8V
	Cycle Charge	Initial Charging Current Less than 1.35A Voltage 14.4-14.9V

## BATTERY DISCHARGE TABLE

### Discharge Constant Current per Cell (Amperes at 25°C)

F.V/Time	5min	10min	15min	30min	45min	1h	2h	3h	5h	8h	10h	20h
1.60V	17.96	11.78	8.65	5.13	3.74	2.94	1.86	1.27	0.85	0.57	0.45	0.238
1.67V	17.11	11.29	8.46	5.05	3.68	2.84	1.83	1.25	0.84	0.56	0.44	0.233
1.70V	16.39	10.67	8.34	4.98	3.64	2.75	1.79	1.23	0.82	0.55	0.44	0.230
1.75V	15.62	10.18	7.90	4.82	3.54	2.67	1.76	1.20	0.80	0.54	0.43	0.225
1.80V	14.43	9.48	7.37	4.62	3.42	2.59	1.69	1.16	0.77	0.53	0.42	0.222

### Discharge Constant Power per Cell (Watts at 25°C)

F.V/Time	5min	10min	15min	30min	45min	1h	2h	3h	5h	8h	10h	20h
1.60V	33.45	22.60	16.71	9.98	7.30	5.78	3.65	2.51	1.68	1.14	0.90	0.474
1.67V	32.05	21.69	16.39	9.84	7.21	5.58	3.58	2.46	1.65	1.12	0.89	0.467
1.70V	30.74	20.51	16.21	9.73	7.14	5.38	3.51	2.42	1.62	1.10	0.89	0.462
1.75V	29.44	19.59	15.38	9.44	6.96	5.18	3.45	2.37	1.59	1.09	0.87	0.452
1.80V	27.45	18.32	14.37	9.09	6.75	4.98	3.31	2.28	1.53	1.07	0.86	0.450

**Note** The above data are average values, and can be obtained within 3 charge/discharge cycles. These are not minimum values. Cell and battery designs/specifications are subject to modification without notice. Contact **MCA** for the latest information.

## PERFORMANCE CHARACTERISTICS

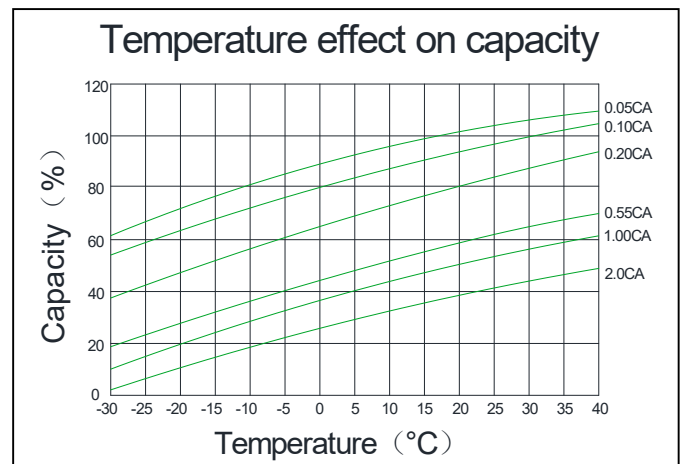
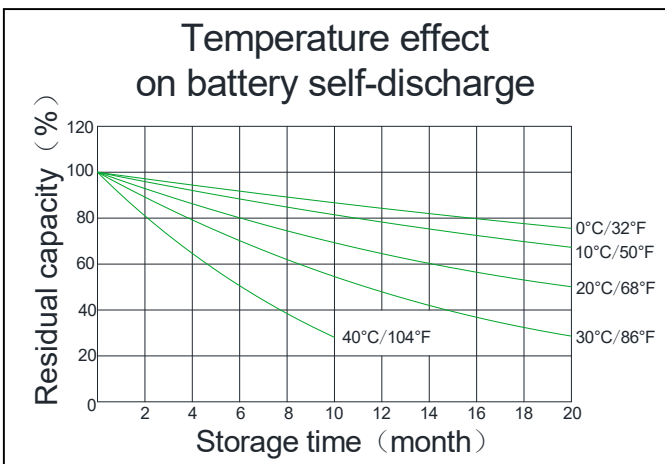
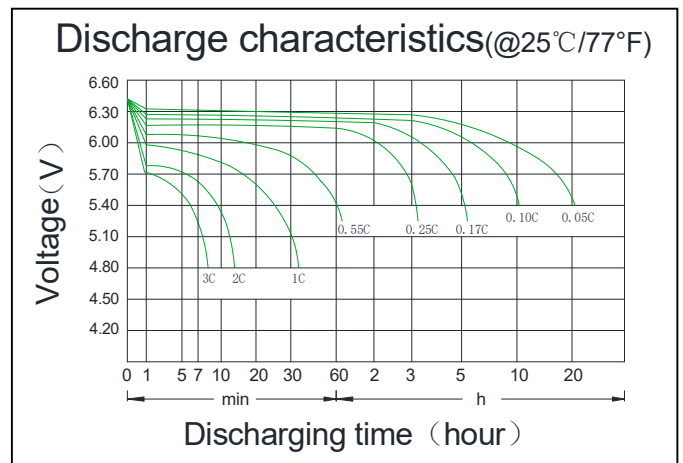
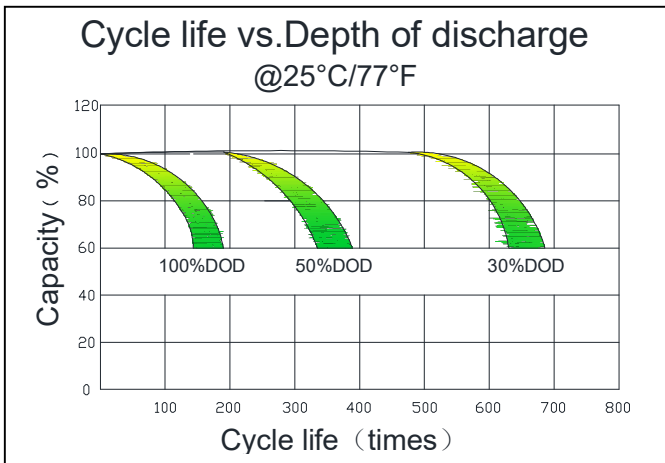
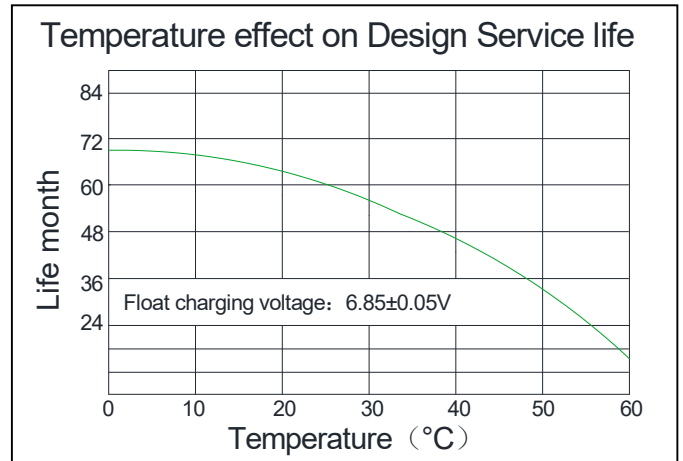
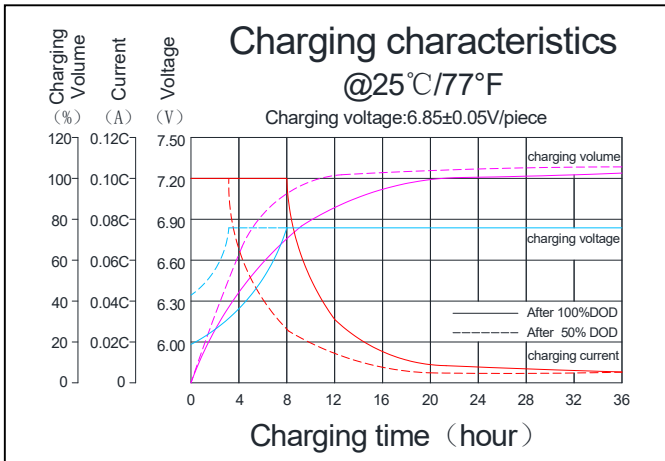

## BATTERY CONSTRUCTION

Component	Positive plate	Negative plate	Container & Cover	Safety valve	Terminal	Separator	Electrolyte	Pillar seal
Features	Thick high Sn low Ca grid with special paste	Balanced Pb-Ca grid for improved recombination efficiency	ABS (UL94-V0 optional)	Flame Si-Rubbeand aging resistancer	Female Copper Insert (F1/F2)	Advanced AGM separator for high pressure cell design	Dilute high purity sulphuric acid	Two layers epoxy resin seal